

panel not included

AC-STAND-75

INTERACTIVE FLAT PANEL STAND/CART

USER MANUAL

The AC-STAND-75 is designed to fit interactive flat panel displays up to 75 inches. Please review this guide to learn how to safely use your product.

Specifications:

Model		AC-STAND-75
VESA Dimensions Adjustable Mounting Brackets (mm)		400x200, 400x400, 600X200, 600X400, 800X400
Exterior Dimensions	Inch	17 (D) x 37.75 (W) & 70.25 (H)
	mm	432 (D) x 959 (W) & 1784 (H)
Product Weight (Weight Without Devices)		62 lbs (28 kg)
Shipping Weight		70 lbs (31.6 kg)
Maximum Display Size Supported		supports up to 75 inch (1905 mm)
Supported Devices		Wall mount televisions and flat panels
Power Specifications		NA
Charging Type		NA
Security		NA
Casters		Four 4" Casters; 2-Locking, 2-Directional
Work Platform Loading		200 lbs (90.7 kg)
Working Temperature		NA
Working RH%		NA
Storage Temperature		NA
Storage RH%		5% - 95%
Warranty		Lifetime Frame, 2 Years Components

Specifications subject to change without notice.

The AC-STAND-75 is designed to fit interactive flat panel displays up to 75 inches.

Please review this guide to learn how to safely use your product.

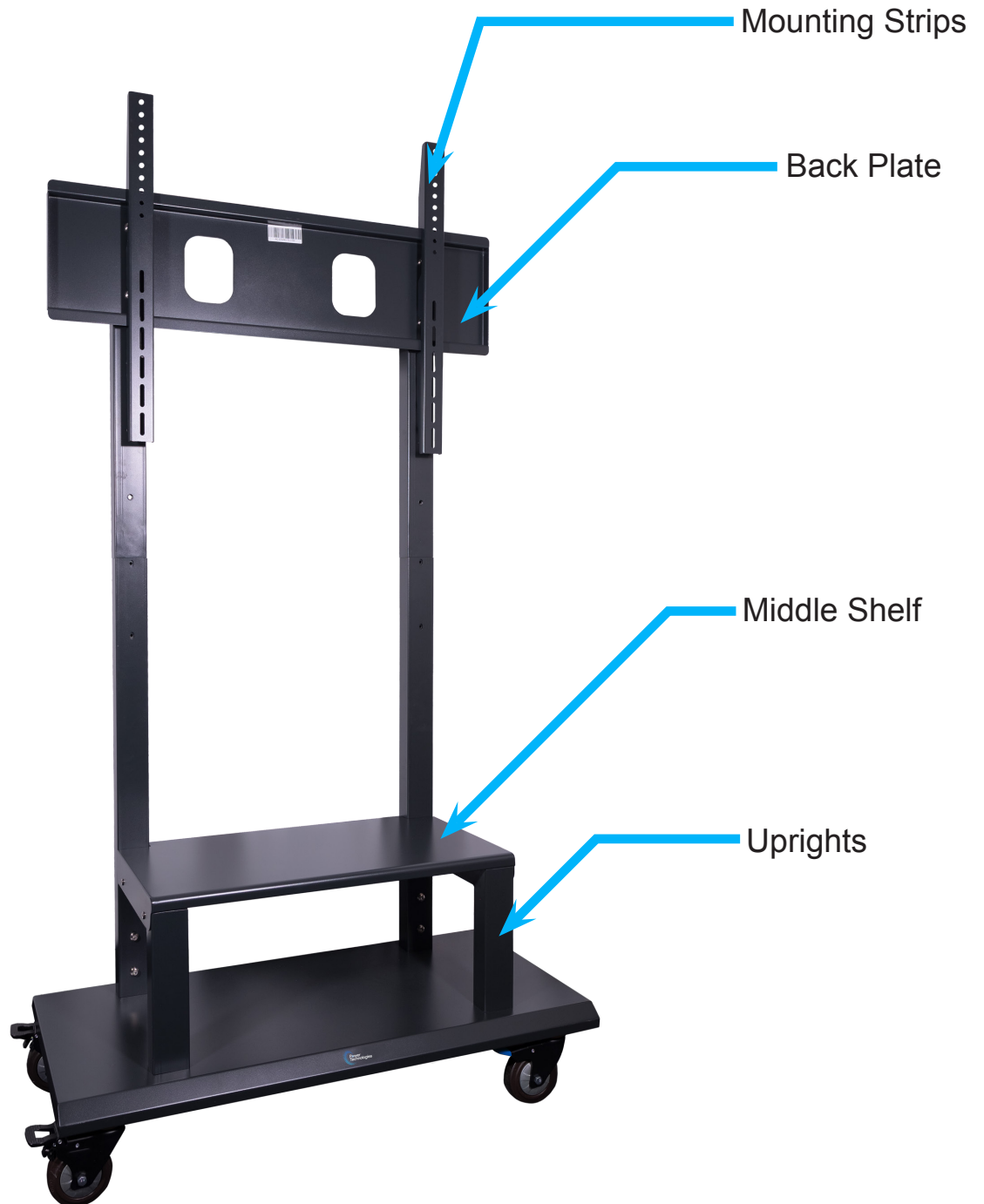

Front View of Stand

If the device (Laptop / Chromebook) thickness is more than the gap between the dividers, remove one of the dividers to create enough space for your device.

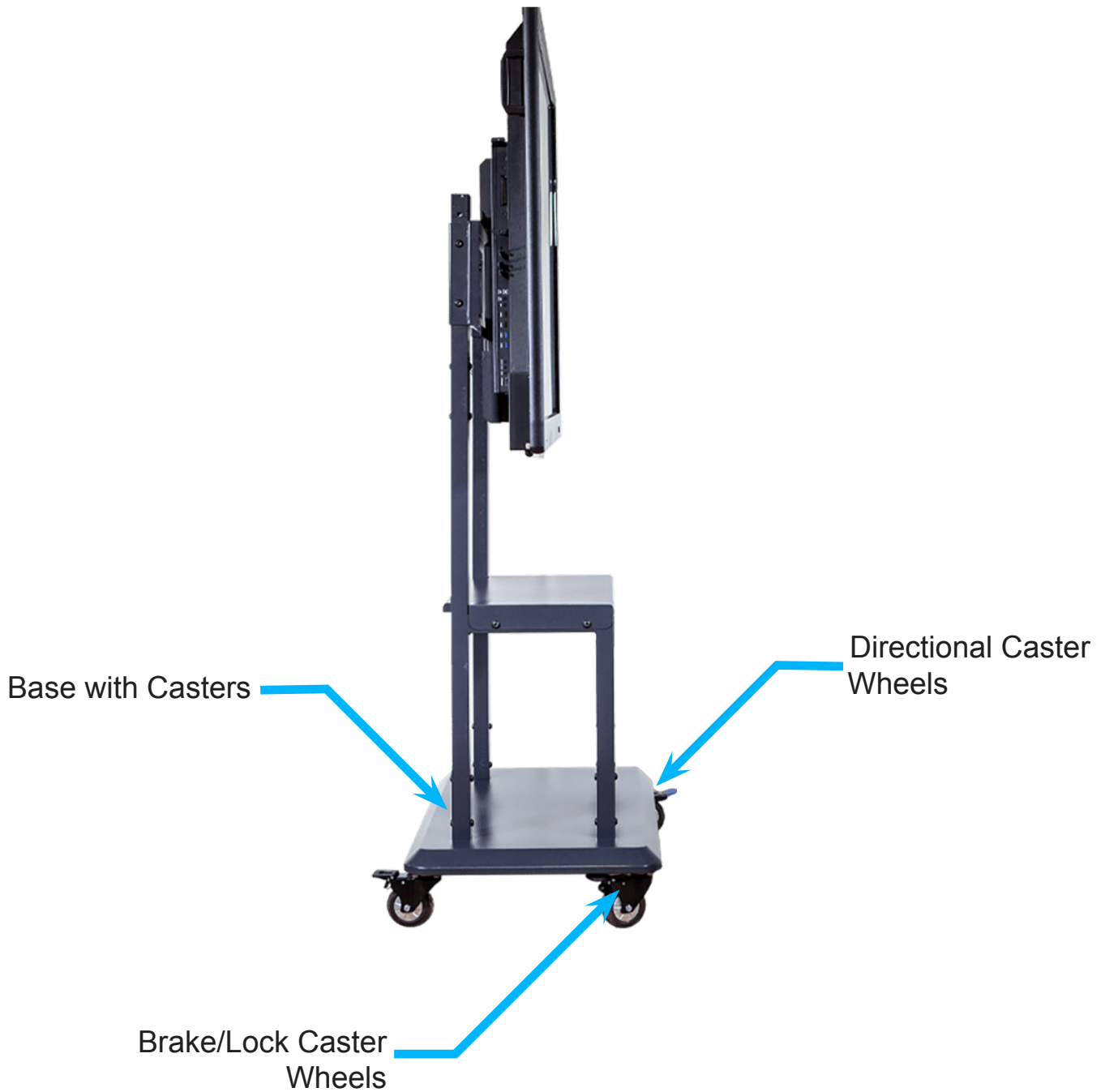

Right View of Stand

panel not included

REMOVING FROM BOX

Step-1: Remove the strapping with scissors or plier cutters. Do not use a box cutter.

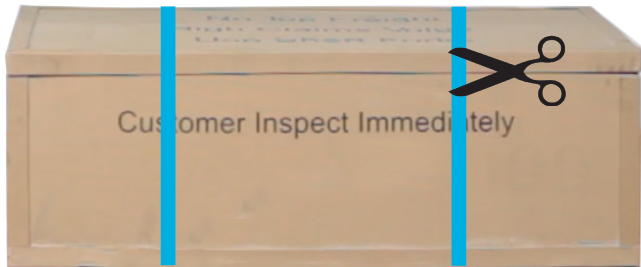

Step-2: Lift and Remove the top cardboard lid

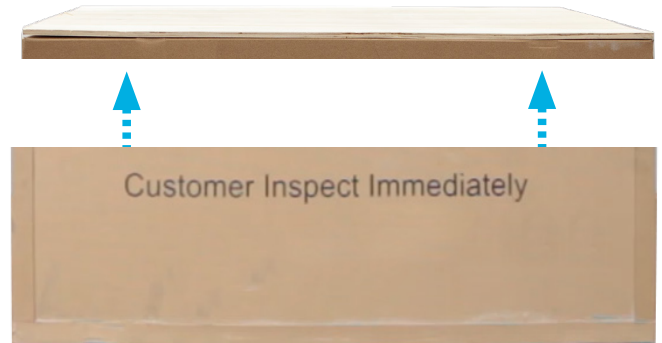

Step-3: Your Stand arrives in 1 box and contains 4 layers for ease of assembly.

Layer 1

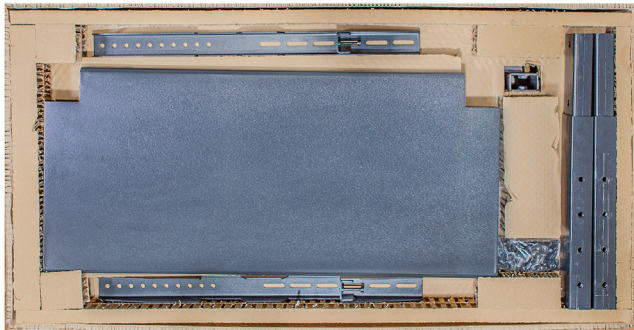

Layer 2

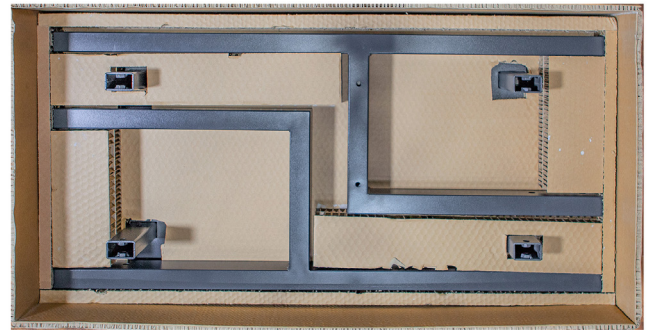

Layer 3



Layer 4

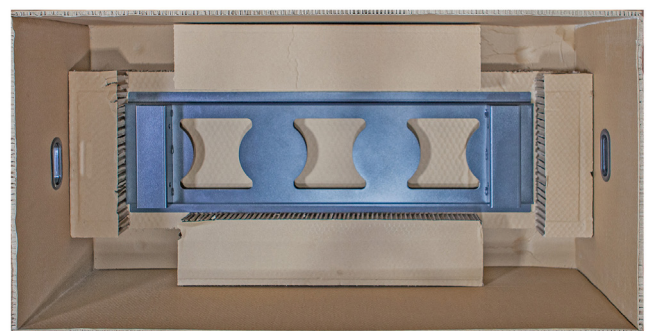

Identifying Parts

1. Carefully remove all parts from box.
2. Locate the bag of hardware as this will be needed throughout the installation.
3. Lay parts out on a flat surface (see below).
4. Ensure no parts are missing.

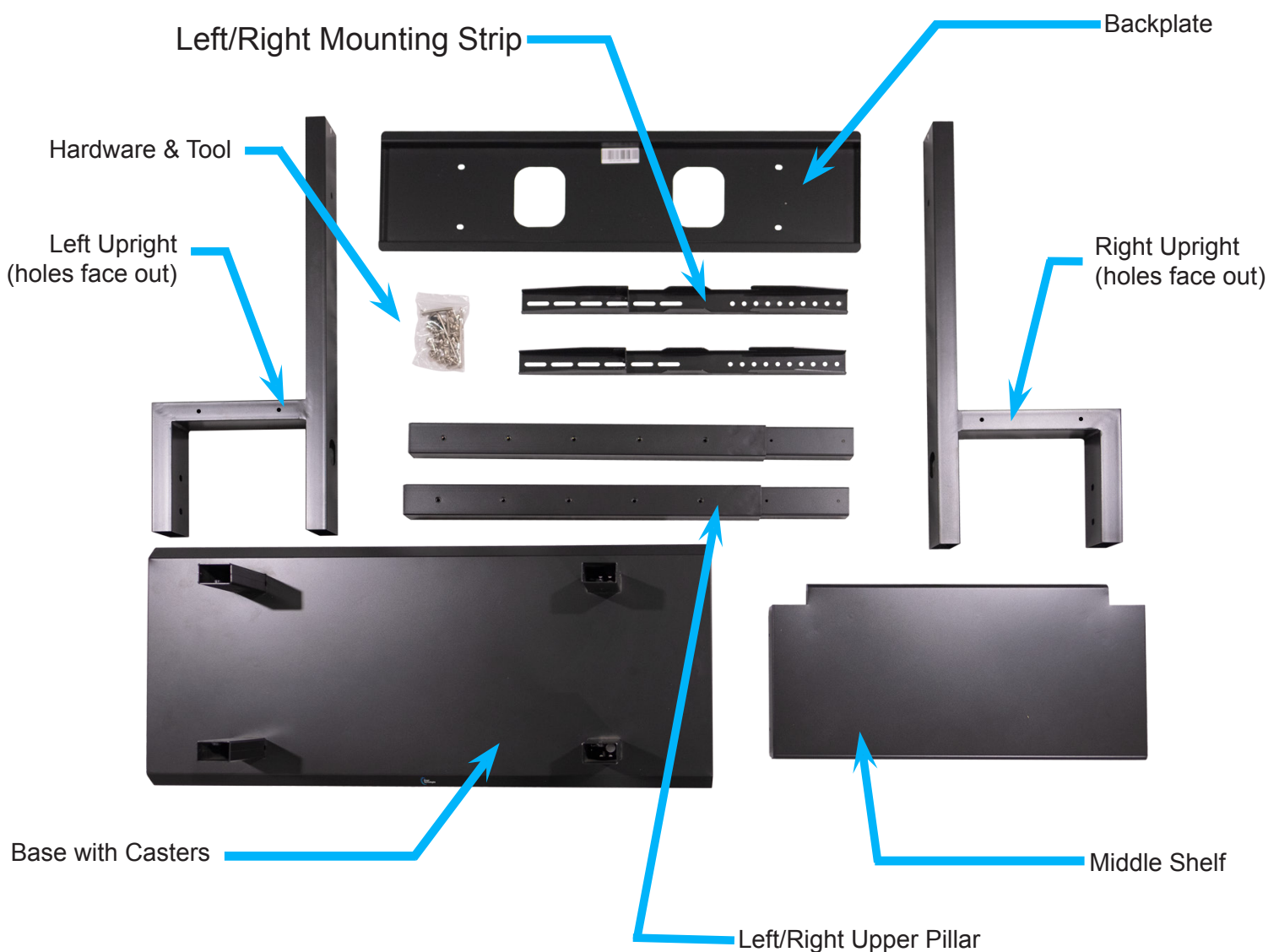

SETTING UP STAND :

Step-1: Place the Base on a flat surface.

Step-2: Find the Uprights and ensure the holes are on the outside.

Step-3: Slide both left and right Uprights into the Base's posts.

Step-4: Loosely fit the screws connecting the left and right uprights to the base of the stand. Do not fully tighten hardware at this point.

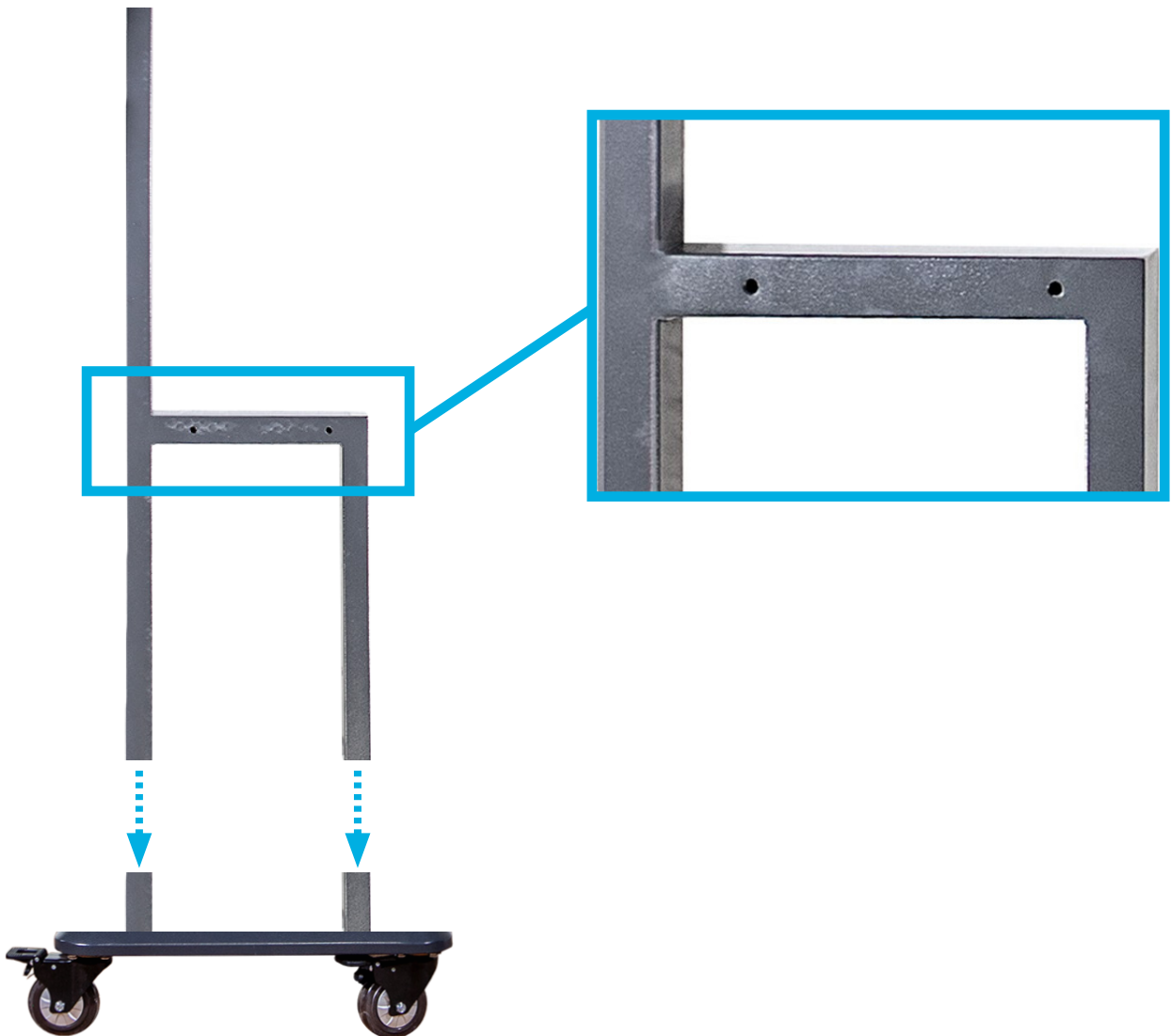

SETTING UP STAND :

Step-5: Find the Middle Shelf.

Step-6: Slide it in place so the notches are toward the long (back) edges of the Uprights.

Step-7: Loosely fit the screws on the outside of the left and right uprights to connect the middle shelf. Do not fully tighten hardware at this point.



SETTING UP STAND :

Step-8: Find the Left and Right Upper Pillars.

Step-9: Fit them into the Uprights so the 4 holes are facing the sides.

Step-10: Loosely fit the screws connecting the left and right upper pillars to the uprights. Do not fully tighten hardware at this point.



SETTING UP STAND :

Step-11: Find the Backplate.

Step-12: Facing the back of the stand, Fit the Backplate onto the Uprights so the post slides are facing you.

Step-13: Loosely fit the screws connecting the backplate onto the upper pillars. Do not fully tighten hardware at this point.



see page 12 for instructions

SETTING UP STAND :

Step-15: Starting from the top, working to the bottom, tighten all hardware with the provided hex wrench.

Step-16: The Left and Right Mounting Strips are installed on your flat panel screen using your own VESA mounting bolts and hung onto the Backplate.



Anti-tip supports are factory installed in the base of the cart.

They need to be deployed prior to the installation of the panel and when the cart is in any stationary position.



To remove the bars, loosen the thumb screws located in the bar socket.

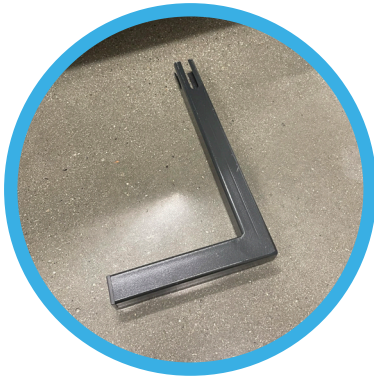

Pull the bars straight out.



Rotate the bars 90 degrees and re-insert the bars until they are seated.

Retighten the thumb screws under underneath the cart.



Photo shows bars that have been properly installed.

Casters Positions

This cart is equipped with Casters that have an “Blue” color foot pedal.

Engage the Directional Locking Casters by pressing the blue foot pedal down. Your cart will now easily track in a straight line.

Release the Direction Lock by lifting up on the foot pedal. The cart will have its full swivel motion restored.



“Engage the BLACK foot pedal to securely lock the wheels, keeping the cart safely in place.”



“Engage the blue foot pedal for a seamless and precise straight-line movement, making navigation a breeze.”

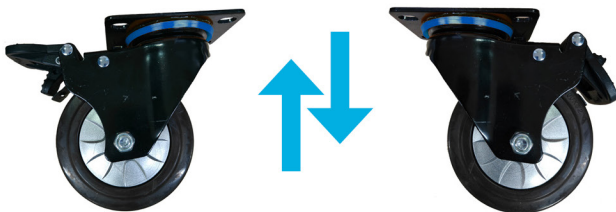

“With a simple release of the BLACK foot pedal, allowing you to navigate effortlessly with unparalleled flexibility.”

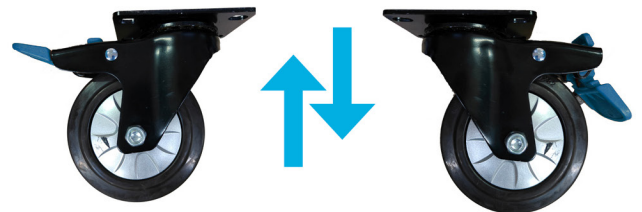

“With a simple release of the blue foot pedal, embrace a world of precision and grace in your swivel motion, making maneuvering a breeze.”

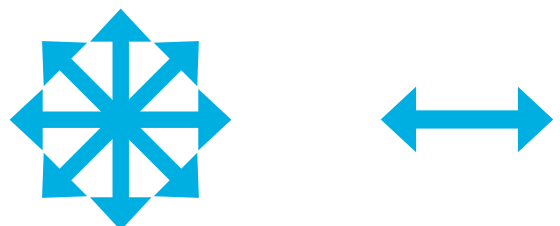

CAUTION
NOTICE

THIS IS NOT A TOY.
ALWAYS FOLLOW SAFETY INSTRUCTIONS.

DANGER
WARNING

 **WARNING**

THE ELECTRICAL SYSTEM IS DESIGNED TO HANDLE A MAXIMUM OF 1500 WATTS.
If wattage exceeds 1500W at one time, the charging system may not operate correctly.
Remove devices until the total wattage is under 1500W.

- ALWAYS FOLLOW SAFETY PRECAUTIONS.**
- **ONLY ADULTS** should move the stand.
 - **NEVER** climb, sit on or tilt the stand.
 - **ALWAYS** move the cart slowly and be aware of your surroundings.
 - **ALWAYS** extend and secure tilt bars to avoid tipping.
 - **DO NOT** mount any panel over 75”.
 - **DO NOT** mount any panel over 120lbs.
 - **DO NOT** remove this decal.

 **NEVER** run over the cord.



 **NEVER** cross thresholds at an unsafe speed.



 **ALWAYS** set the cater break when done moving.



For warranty claims, please have the following information ready, then visit : www.powertechnologies.com

To create a help ticket.

Serial Number:

Product:

Date Of Purchase:

Reseller Name:

PO Number:

 **DO NOT** touch any part of the electrical system while plugged in.



 **DO NOT** connect the stand with broken electrical components.



 **DO NOT** use an extension cord with this unit.



For further information on this product and others, contact Power Technologies at.

Power Technologies
42035 Zevo Dr.
Temecula, CA 92590
888.650.4488

support@powertechnologies.com

www.powertechnologies.com
