



AC-COLLABR-8
ROLLING CHARGE STAND
USER MANUAL

Designed to charge up to 16 Mobile , Chromebooks, laptops or tablets, Digital projector, etc.

Specifications:

Model		AC-COLLABR-8
Exterior Dimensions	Inch	39.25 (H) x 17.25 (W) x 17.25 (D)
	mm	997 (H) x 439 (W) x 439 (D)
Product Weight (Without Devices)		27 lbs (12.24 kg).
Shipping Weight		30 lbs (13.6 kg).
Capacity		Upto 16 Devices
Battery Capacity		40 Ah, @12 V, 480-500 Wh
Supported Devices		Mobile, Chromebooks, laptops or tablets, etc.
Charging Port		USB-A ports are 5 V, 2.4A for 12 W total power
Power Specifications (For carts sold within North America)		AC IN/ Power Strip: 110V AC, 50/60Hz, 2-12 A Maximum power: 1400W
Power Specifications (For carts sold outside North America)		AC IN/ Power Strip: 100-240V AC, 50/60Hz, 2-12 A Maximum power: 2400W
Charging Type		Basic Charger
Security		NA
Casters		Four 3 inch (76 mm) Swivel / Lock Casters
Expected Battery Life span		Life Span Of 2000 Cycles
Working Temperature		0°- 30°c
Working RH%		10% - 90%
Storage Temperature		-40°- 60°C Temp
Storage RH%		5% - 95%
Warranty		Lifetime Frame, 1 Years battery, 2 Years Electronics

Specifications subject to change without notice.

This manual covers the following models and part numbers.
 The manual is based upon the North American 110V product offering.
 Refer to the part numbers below and cord end diagrams for your specific region.

MODEL# AC-COLLABR-8

SKU	DESCRIPTION
MPW-CLB-B8N-D	8x8 Port Mobile Charge Station - 110V NA
MPW-CLB-B8N-E	8x8 Port Mobile Charge Station - 220V UK
MPW-CLB-B8N-U	8x8 Port Mobile Charge Station - 220V EU

Power Cords and Sockets for Specific Region:

US / Canada

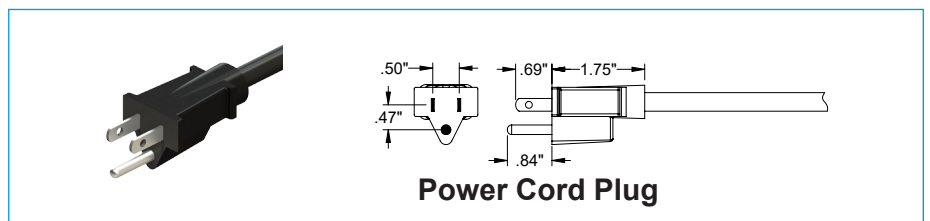
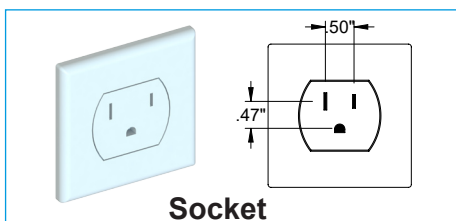

United Kingdom

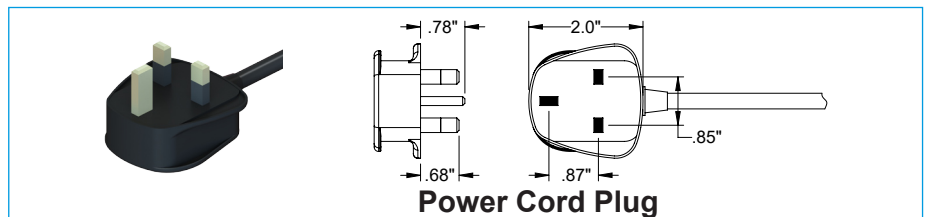
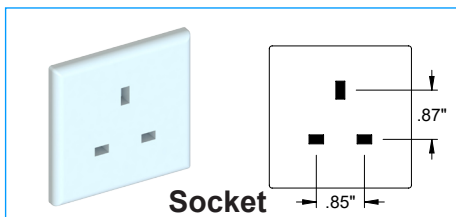

European

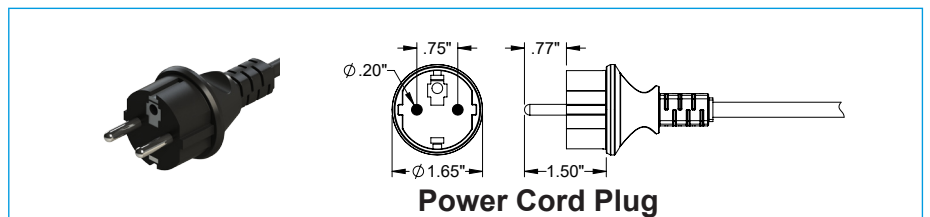
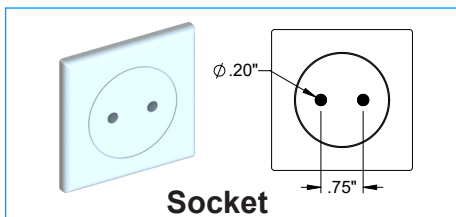

Australian

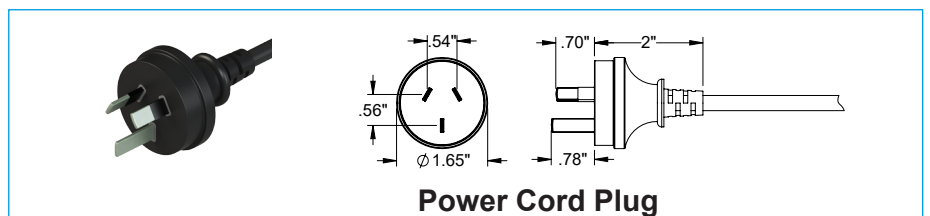
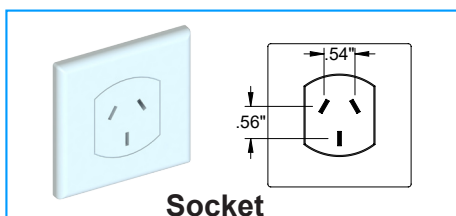

Switzerland Type-J

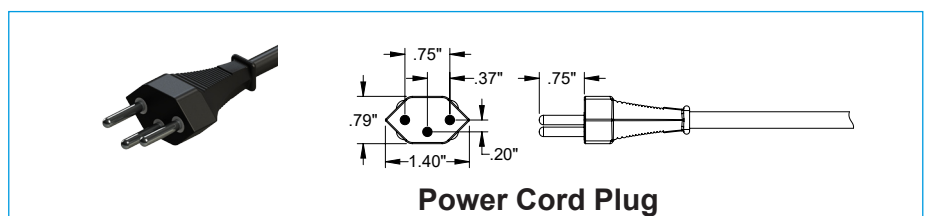
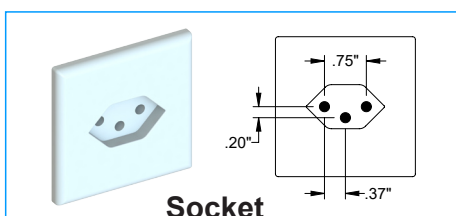

The COLLABR-8 is the perfect solution for providing power to mobile devices. With 2-AC outlets and 2-USB outlets on each side, charge up to 16 devices simultaneously a single three-prong plug.

NOTE: Please review this guide before installing devices and to learn how to safely use your cart.

Key Features Specifications:



Key Features Specifications:

Simultaneously charge 16 devices from a single wall outlet



Installations of Legs:

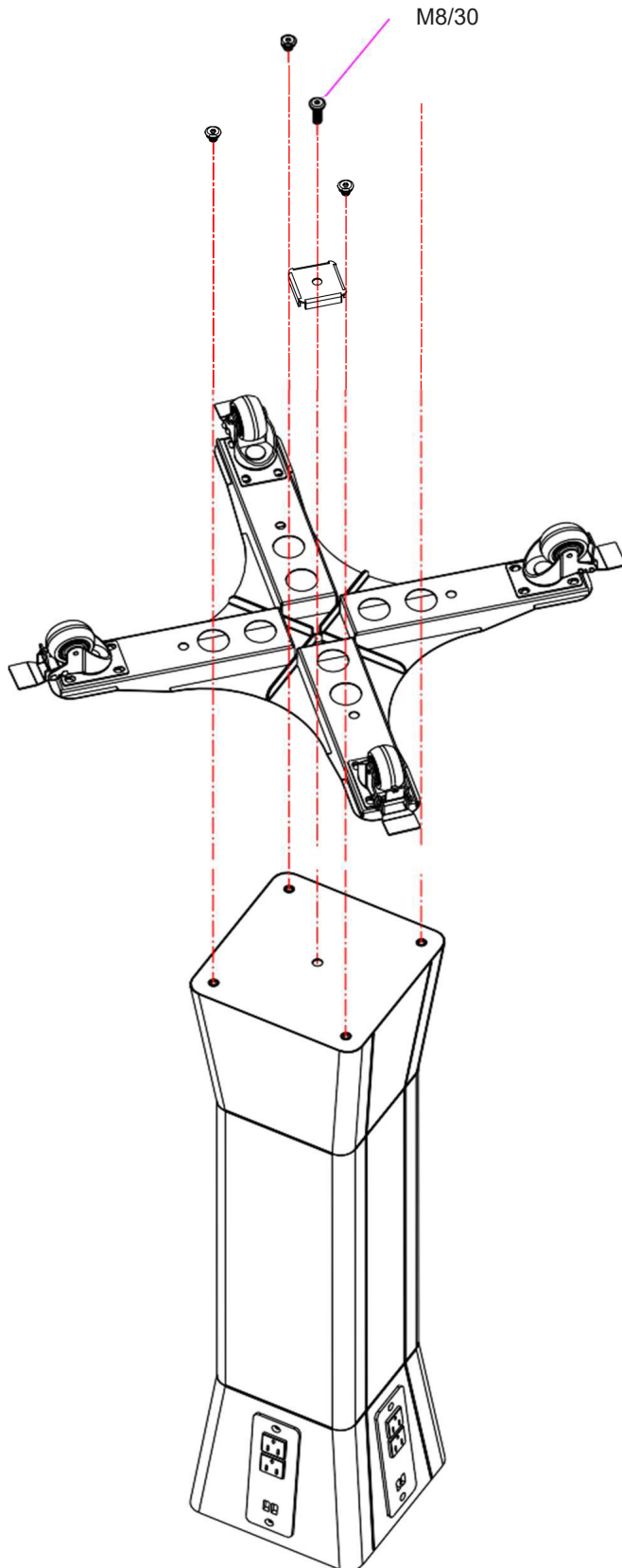

Place the unit on its top. Please place the top on a soft surface or padding to avoid damage to the top of the unit, and battery switch and display screen on BA versions

Install the four legs to the bottom of the charging stand. Use the M8/12 bolts provided to attach each leg in the position as shown.

Do not tighten until centering plate is attached

Attach the centering plate in the center with the M8/30 bolt provided to lock the legs in place. After tighten all four legs after centering plate has been installed

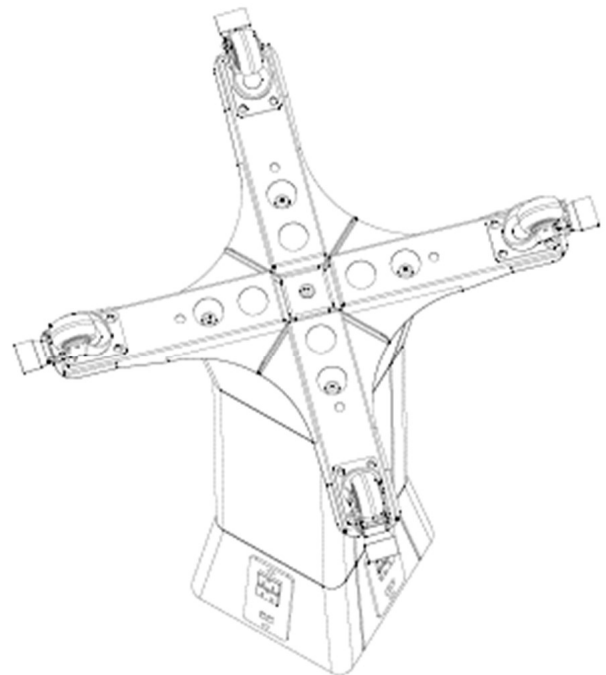

Collabr-8 has low center of gravity which provides stability when moving and avoids tipping.

GENERAL OPERATIONS

Plug the unit into any wall socket and the device is ready for use. Use the AC socket and/or USB-A ports to charge electronic devices as needed.

The display on the top will show the battery level when the “power button” is pressed.

When the battery near depletion there is an audible warning. Once depleted, plug the power adapter that came with the unit into the wall and the barrel connector into the Face of the tower.

Only charge the battery while the unit is not connected to the wall as wall power will take priority over the charging cycle.

Once the Battery has been recharged, disconnect the power supply from the wall and the tower. Store the power supply in a safe place.

The factory settings for these windows are:

1-P 00, 2-L 03, 3-F 00, 00.0 – 000, 5-B - ON
09.09 LOW, 7A – ON

Any changes to these will give incorrect readings on the on-board battery.



LOCK OR UNLOCK THE MOVEMENT OF CART:

This cart is equipped with Casters that have an “BLACK” color foot pedal. Release the Direction Lock by lifting up on the foot pedal. The cart will have its full swivel motion restored.

3” ultra quiet locking casters with a small footprint design



With a simple release of the BLACK foot pedal, allowing you to navigate effortless with unparalleled flexibility.

Engage the BLACK foot pedal to securely lock the wheels, keeping the cart safely in place.

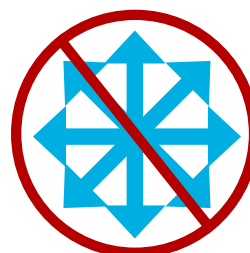

Safety Instructions

	Caution
	Notice

**THIS IS NOT A TOY.
ALWAYS FOLLOW SAFETY INSTRUCTIONS.**

	Danger
	Warning

DO NOT Pull the cart using power cord

Important

THE ELECTRICAL SYSTEM IS DESIGNED TO HANDLE A MAXIMUM OF 1400 WATTS per side. If wattage exceeds 1400W at one time, charging system may not operate correctly. Remove devices until the total wattage is under 1400W.

Don't connect the cart with broken electrical components.

DO NOT place liquids on or near the cart

- ALWAYS move the rooling stand slowly and be aware of your surroundings.
- ALWAYS latch doors before moving the stand
- Repairs should always be performed by a qualified electrician.
- Set the power switch to the OFF position before you unplug the unit from the wall, plug the unit into the wall, or plug in devices.
- If external devices are set on top of the stand, remove them before rolling stand around.
- DO NOT block the ventilation holes used for air circulation.

DO NOT touch any part of the electrical system while plugged in.

DO NOT attempt to move downstairs.

For warranty claims, please have the following information ready, then visit www.powertechnologies.com to create a help ticket.

DO NOT use an extension cord with this unit.

DO NOT Roll the cart over the power cord

Serial Number:

DO NOT allow children to move or climb.

DO NOT ride or run with the cart.

Charging System Type:

Date Of Purchase:

Reseller Name:

PO Number:

ONLY ADULTS should move the cart.

For further information on this product and others, contact Power Technologies at.

Power Technologies
42035 Zevo Dr
Temecula, CA 92590+
888.650.4488

support@powertechnologies.com

www.powertechnologies.com

TROUBLE	Indication	Possible Cause
General Specs	volts and amperage capability of the Collabr-8 BA	The Collabr-8 internal cable can support 20A current but is limited by the plug standards. US - 110V, 15A, UK - 220V 13A; EU - 220V, 110A
	charging capability of USB ports	Current USB ports are 5 V, 2.4A for 12 W total power
	battery capacity	40Ah, @12 V, 480-500Wh
Specs	battery lifespan	The battery has an expected lifespan of 2000 cycles.
	battery warranty	1 year
	new battery	Power technologies can supply any replacement battery needs.
	replace the battery	Contact Power Technologies for detail replacement instructions.
	recycle the battery	Any recycling program that accepts power tool batteries and/or municipal battery recycling programs
Operations		The battery does have overcharge protection, but it is still recommended to unplug the charging cord when charging is complete.
		When both power connectors are connected to the wall, it will automatically switch to the wall powered status.
		The Collabr-8 has no overload as it is pulling from wall power. The Collabr-8BA will automatically turn off when the power exceeds 300W - when powered by the battery. It will not shut off if plugged into wall.
		It does not manage the charging state of the device. It is similar to plugging into a wall outlet - the device or device charging block needs to manage.
		It does not manage power distribution.